



Ekonomik LEDspot çözümü

CorePro LEDspot LV

CorePro LEDspot'lar spot aydınlatma içi mükemmeldir ve halojen benzeri bir ışık sağlar. Bu ürünler MR16 GU5.3 duylu çoğu mevcut armatürle uyumludur ve halojen ya da enkandesan spotların değişimi için tasarlanmıştır. LED lambalar büyük enerji tasarrufu sağlar ve bakım maliyetlerini minimuma indirir.

Faydaları

- Sarı ışık
- Halojen lambalarla karşılaştırıldığında %80'e varan enerji tasarrufu
- Daha düşük bakım giderleri
- Trafolarla uyumlu

Özellikler

- Kolay dönüşüm
- 25.000 ila 45.000 saat kullanım ömrü
- Dimmer anahtarların büyük bölümüyle uyumlu
- UV ve IR yaymaz
- Cıva ve tehlikeli maddeler içermez

Uygulama

- Oteller, restoranlar, barlar, kafeler, müzeler, mağazalar
- Lobiler, koridorlar, merdivenler, duşlar, resepsiyon alanları, sergiler, teşhir kabinleri

CorePro LEDspot LV

Versions



Boyutlu çizim

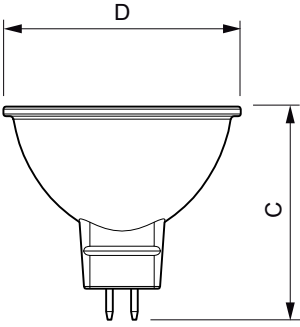

Product	D	C
CorePro LED spot ND 3-20W MR16 827 36D	51 mm	46 mm
CorePro LED spot ND 5-35W MR16 827 36D	51 mm	46 mm
CorePro LED spot ND 5-35W MR16 840 36D	51 mm	46 mm
CorePro LED spot ND 7-50W MR16 827 36D	50,5 mm	45 mm
CorePro LED spot ND 7-50W MR16 840 36D	50,5 mm	45 mm
CorePro LED spot ND 7-50W MR16 830 36D	50,5 mm	45 mm

Kontroller ve Dimming

Karartılabilir	Hayır
----------------	-------

Çalıştırma ve Elektrikle İlgili Bilgiler

Giriş Frekansı	- Hz
Voltaj (Nom)	12 V
Başlangıç Saati (Nom)	0,5 s

Genel Bilgiler

Kapak Tabanı	GU5.3
Nominal Kullanım Ömrü (Nom)	15000 h
Anahtar Döngüsü	50000X

Işık Teknik Ayrıntıları

Işın Açısı (Nom)	36 °
Renksel Geriverim İndeksi (Nom)	80
Nominal Kullanım Ömrü Sonundaki Llmf (Nom)	70 %

Mekanik Ayrıntılar ve Muhafaza

Lamba Biçimi	MR16
--------------	------

Onay ve Uygulama

Order Code	Full Product Name	Enerji Tüketimi kWh/1000 sa
71061600	CorePro LED spot ND 3-20W MR16 827 36D	3 kWh
71063000	CorePro LED spot ND 5-35W MR16 827 36D	6 kWh
71065400	CorePro LED spot ND 5-35W MR16 840 36D	6 kWh
81471000	CorePro LED spot ND 7-50W MR16 827 36D	7 kWh
81477200	CorePro LED spot ND 7-50W MR16 830 36D	7 kWh
81479600	CorePro LED spot ND 7-50W MR16 840 36D	7 kWh

Çalıştırma ve Elektrikle İlgili Bilgiler

CorePro LEDspot LV

Order Code	Full Product Name	Güç (Nominal)	
		Güç Eşleniği (Nom)	
71061600	CorePro LED spot ND 3-20W MR16 827 36D	20 W	3 W
71063000	CorePro LED spot ND 5-35W MR16 827 36D	35 W	5 W
71065400	CorePro LED spot ND 5-35W MR16 840 36D	35 W	5 W

Order Code	Full Product Name	Güç (Nominal)	
		Güç Eşleniği (Nom)	
81471000	CorePro LED spot ND 7-50W MR16 827 36D	50 W	7 W
81477200	CorePro LED spot ND 7-50W MR16 830 36D	50 W	7 W
81479600	CorePro LED spot ND 7-50W MR16 840 36D	50 W	7 W

Işık Teknik Ayrıntıları

Order Code	Full Product Name	Renk Kodu	Renk		
			Sıcaklığı (Nom)	Işık Akışı (Nom)	Işık Yoğunluğu (Nom)
71061600	CorePro LED spot ND 3-20W MR16 827 36D	827	2700 K	230 lm	600 cd
71063000	CorePro LED spot ND 5-35W MR16 827 36D	827	2700 K	345 lm	650 cd
71065400	CorePro LED spot ND 5-35W MR16 840 36D	840	4000 K	390 lm	650 cd

Order Code	Full Product Name	Renk Kodu	Renk		
			Sıcaklığı (Nom)	Işık Akışı (Nom)	Işık Yoğunluğu (Nom)
81471000	CorePro LED spot ND 7-50W MR16 827 36D	827	2700 K	621 lm	1400 cd
81477200	CorePro LED spot ND 7-50W MR16 830 36D	830	3000 K	621 lm	1400 cd
81479600	CorePro LED spot ND 7-50W MR16 840 36D	840	4000 K	660 lm	1500 cd

Sıcaklık

Order Code	Full Product Name	Muhafaza Maksimum (Nom)
71061600	CorePro LED spot ND 3-20W MR16 827 36D	68 °C
71063000	CorePro LED spot ND 5-35W MR16 827 36D	82 °C
71065400	CorePro LED spot ND 5-35W MR16 840 36D	82 °C
81471000	CorePro LED spot ND 7-50W MR16 827 36D	85 °C
81477200	CorePro LED spot ND 7-50W MR16 830 36D	85 °C
81479600	CorePro LED spot ND 7-50W MR16 840 36D	85 °C

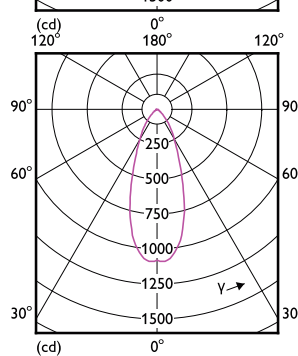
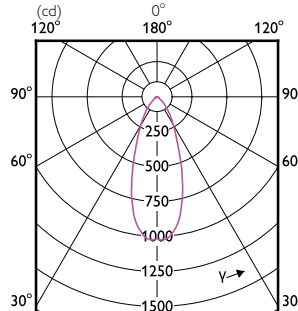
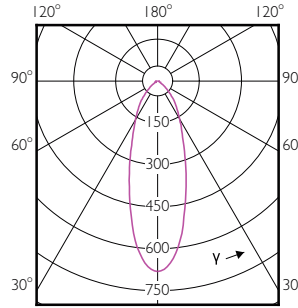
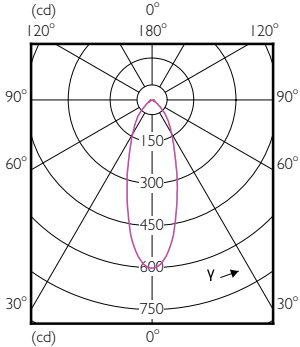
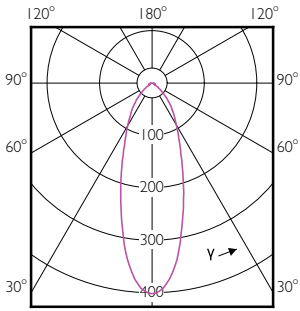

CorePro LEDspot LV

Accent Diagrams

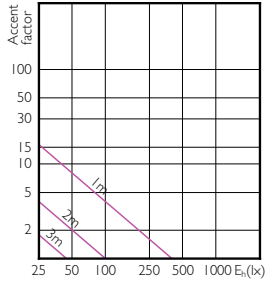

CorePro LEDspotLV 20W GU5-3 827 36D

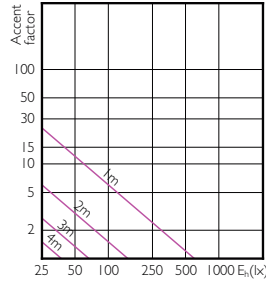

CorePro LEDspotLV 35W GU5-3 827 36D

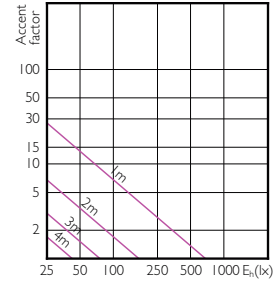

CorePro LEDspotLV 35W GU5-3 840 36D

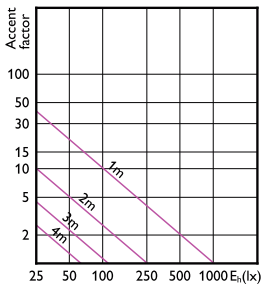

LEDspot Corepro 7-50W GU5.3 MR16 827 36D

ND

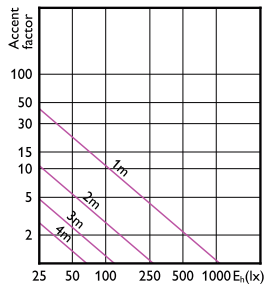

LEDspot MAS VLE 7-50W GU5.3 MR16 840 36D

DIM

Beam Diagrams

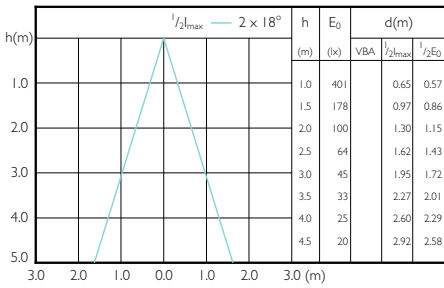

CorePro LEDspotLV 20W GU5-3 827 36D

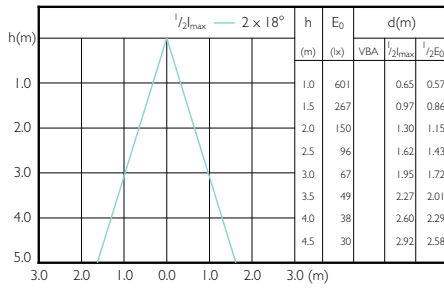

CorePro LEDspotLV 35W GU5-3 827 36D

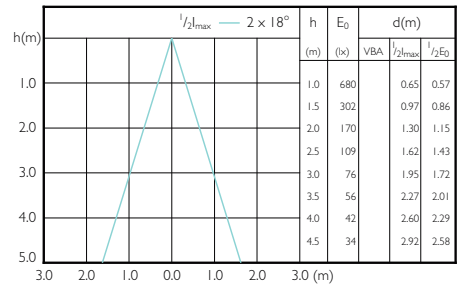

CorePro LEDspotLV 35W GU5-3 840 36D

CorePro LEDspot LV

Beam Diagrams

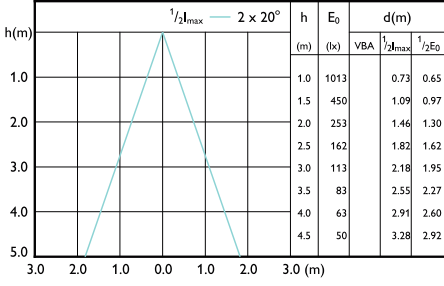

LEDspot Corepro 7-50W GU5.3 MR16 827 36D
ND

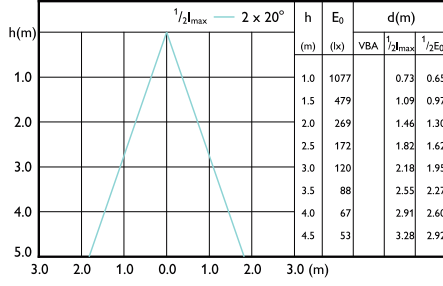

LEDspot MAS VLE 7-50W GU5.3 MR16 840 36D
DIM

